

**2-1/4" Ball Sets**

Billiards

**Belgian**

**Belgian  
First Quality**

(Ball #9 Through #15 In The Stripe )



**B0002 – Premier W/2-1/4" CB**  
**B1970 – Premium W/2-1/4" CB**

**Belgian  
Standard Quality**

(Ball #9 Through #15 In The Field)



**B0006 – Standard W/2-3/8" CB**  
**B0007 – Standard W/2-1/4" CB**  
**B3183 – Standard W/Magnetic CB**  
**B3268 – Standard W/Green "S" CB**

**Grade "A"**

**Economy**

(Ball #9 Through #15 In The Stripe)

**Economy**



**GREAT VALUE – A  
HARD SURFACE  
AT A VERY  
AFFORDABLE  
PRICE**



**B2088 – Grade "A" W/2-3/8" CB**  
**B2089 – Grade "A" W/2-1/4" CB**  
**B3670 – Grade "A" W/Magnetic CB**  
**B1782 – Grade "A" W/2 Ea. #8 Balls**

**B3550 – Economy W/2-1/4" CB**  
**B3551 – Economy W/ Magnetic CB**

**6880 South Emporia Street Centennial, Colorado 80112**  
**303-790-0885 – 303-790-0746 – FAX**  
**Toll-Free: 1-800-525-7059**

**e-mail: game@amusemp.com – www.amusementemporium.com**

**Cue Balls**

**Belgian**

**Valley Magnetic**

- B3207 – Green “S” First Quality**
- B3428 – Green “S” Standard Quality**
- B3521 – Green “S” First Quality, Cougar Logo**



- B0030 – “Cats Eye” First Quality**
- B0027 – “Cats Eye” Standard Quality**



- B1733 – “Green Dot” Weighted/Magnetic**

- B1016 – Oversized, 2-3/8" – Non-Magnetic**
- B1017 – Home Style, 2-1/4" – Non-Magnetic**

**Dynamo**

- B0031 – Orange Dot, First Quality**
- B0026 – Orange Dot, Standard Quality**



- B0041 – Crazy**

**USA**

- B3008 – Green Dot Magnetic**
- B0789 – First Quality “Universal” Metal Flake Weighted/Magnetic – “Mudball”**



**Economy**

- B0781 – Magnetic**
- B1718 – Oversize 2-3/8"**
- B1721 – Crazy**

**6880 South Emporia Street Centennial, Colorado 80112**  
**303-790-0885 – 303-790-0746 – FAX**  
**Toll-Free: 1-800-525-7059**

**e-mail: [game@amusemp.com](mailto:game@amusemp.com) – [www.amusementemporium.com](http://www.amusementemporium.com)**

**Individual Balls**

**Belgian**

**Economy  
Grade "A"**

**Economy**

**Billiards**

Ball#	Stock#	Stock#	
1	B1001	B1701	
2	B1002	B1702	
3	B1003	B1703	
4	B1004	B1704	
5	B1005	B1705	
6	B1006	B1706	
7	B1007	B1707	
8	B1008	B1708	
	<b># In The Stripe</b>	<b># In The Field</b>	<b># In The Stripe</b>
9	B1009	B1033	B1709
10	B1010	B1034	B1710
11	B1011	B1035	B1711
12	B1012	B1036	B1712
13	B1013	B1037	B1713
14	B1014	B1038	B1714
15	B1015	B1039	B1715
<b>Crazy 8</b>	<b>B0042</b>		<b>B3552</b>
			<b>B1720</b>

**Ball Cleaning And Care Products**



**B2004  
Ball Cleaning  
Cloth**



**B1890  
Ball  
Cleaner**



**B3513  
Ball  
Restorer  
(For Deep  
Marks And  
Scratches)**

**Genuine Belgian  
Ball Care Products**



**B1357  
Karseal Ball  
Cleaner**



**B3117 Wildcat  
Ball Cleaner**



**B3289 – Ball  
Polish Machine  
W/ Manual  
Applicator**



**B1972 – Ball  
Polish Machine  
Disk Pads  
3-Pack**



**B3378 – Ball  
Polish Machine  
Cleaning Solution  
Liter**

**6880 South Emporia Street Centennial, Colorado 80112  
303-790-0885 – 303-790-0746 – FAX  
Toll-Free: 1-800-525-7059**

**e-mail: [game@amusemp.com](mailto:game@amusemp.com) – [www.amusementemporium.com](http://www.amusementemporium.com)**

AMUSEMENT EMPORIUM<sup>TM</sup> Inc.

***Ball Trays & Sweep Brushes***

**B0043 – Black 16 Ball; Stackable**



**B1519 – Black 16 Ball; Stackable With Lip**

**“Horsehair” Bristles**



**B0057 – 10-1/2"**

**Nylon Bristles**



**B3572 – 9" Plastic Handle**

**Rail**



**B0053**



**B0055 – 9"**



**B0056 – 10-1/2"**

***Other Colors And Styles Available Call Your Sales Representative***

**6880 South Emporia Street Centennial, Colorado 80112  
303-790-0885 – 303-790-0746 – FAX  
Toll-Free: 1-800-525-7059**

**e-mail: [game@amusemp.com](mailto:game@amusemp.com) – [www.amusementemporium.com](http://www.amusementemporium.com)**



# AE



***Please See Our  
Center Section  
For Selected  
2-Piece Cues  
and Cases For  
The Amusement  
Industry***

**One-Piece Cues**

**Length**

**Tip/Ferrule**

**Weights**

**57"**

**Elk Master  
Fiber – 13mm**

**B0300  
B0301**

**15 oz. – 17 oz.  
18 oz. – 21 oz.**

**FEATURES:**  
 – Valley Brand  
 – 4-Prong Hardwood Butt  
 – Canadian Maple Shaft  
 – Naturally Weighted

**57"**

**Elk Master  
Fiber – 13mm**

**B3493  
B3457  
B3665 – Pro Taper**

**15 oz. – 17 oz.  
18 oz. – 21 oz.  
18 oz. – 21 oz.**

**FEATURES :**  
 – 4-Prong Hardwood Butt  
 – Canadian Maple Shaft  
 – Naturally Weighted

**57"**

**Elk Master  
Fiber – 13mm**

**B3594  
B3664 – Pro Taper**

**17 oz. – 21 oz.  
17 oz. – 21 oz.**

**FEATURES :**  
 – 4-Prong Hardwood Butt  
 – Oriental Maple Shaft  
 – Most Are Naturally Weighted

B0300  
B0301

B3493  
B3457  
B3665

B3594  
B3664

**6880 South Emporia Street Centennial, Colorado 80112  
 303-790-0885 – 303-790-0746 – FAX  
 Toll-Free: 1-800-525-7059**

**e-mail: [game@amusemp.com](mailto:game@amusemp.com) – [www.amusementemporium.com](http://www.amusementemporium.com)**

**One-Piece Cues**

<u>Length</u>	<u>Tip/Ferrule</u>	<u>Weights</u>
<b>57"</b>	<b>Fiber – 13 mm</b>	
<b>B3593</b>	<b>Glue-On - Elk Master</b>	<b>17 oz. – 21 oz.</b>
<b>B3592</b>	<b>Slip-On</b>	<b>17 oz. – 21 oz.</b>

**FEATURES :**  
 – Hardwood 4-Prong Butt  
 – Hardwood Shaft  
 – Most Are Naturally Weighted

<u>Length</u>	<u>Tip/Ferrule</u>	<u>Weights</u>
<b>57"</b>	<b>Leather/Plastic 12 mm</b>	
<b>B3591</b>	<b>Screw-In</b>	<b>17 oz. – 21 oz.</b>
<b>B3590</b>	<b>Glue-On</b>	<b>17 oz. – 21 oz.</b>
<b>B3589</b>	<b>Slip-On</b>	<b>17 oz. – 21 oz.</b>

**FEATURES :**  
 – Brown 4-Prong Painted Butt With Rings  
 – All Hardwood  
 – Weighted

<u>Length</u>	<u>Tip/Ferrule</u>	<u>Weights</u>
<b>57"</b>	<b>12 mm</b>	
<b>B3636</b>	<b>Slip-On, Weighted</b>	<b>17 oz. – 21 oz.</b>
<b>B3601</b>	<b>Slip-On, Naturally Weighted</b>	<b>15 oz. – 18 oz.</b>

**FEATURES :**  
 – Fully Stained Dark Brown With Rings  
 – All Hardwood



B3593  
B3592

B3591  
B3590  
B3589

B3636  
B3601

**6880 South Emporia Street Centennial, Colorado 80112  
 303-790-0885 – 303-790-0746 – FAX  
 Toll-Free: 1-800-525-7059**

**e-mail: [game@amusemp.com](mailto:game@amusemp.com) – [www.amusementemporium.com](http://www.amusementemporium.com)**

**One-Piece Cues**

**Length                      Tip/Ferrule                      Weights**

**Leather/Fiber  
12.5 mm**

<b>B1833</b>	<b>52"</b>	<b>14 oz. – 16 oz.</b>
<b>B1832</b>	<b>48"</b>	<b>12 oz. – 14 oz.</b>
<b>B1831</b>	<b>42"</b>	<b>10 oz. – 12 oz.</b>
<b>B1830</b>	<b>36"</b>	<b>8 oz. – 10 oz.</b>

**FEATURES:**  
 – Hardwood 4-Prong Butt  
 – Canadian Maple Shaft  
 – Naturally Weighted

**Leather/Plastic  
12 mm**

<b>B3219</b>	<b>52"</b>	<b>13 oz. – 16 oz.</b>
<b>B3220</b>	<b>48"</b>	<b>12 oz. – 14 oz.</b>
<b>B3221</b>	<b>42"</b>	<b>10 oz. – 13 oz.</b>
<b>B3222</b>	<b>36"</b>	<b>8 oz. – 11 oz.</b>

**FEATURES:**  
 – 4-Prong Painted Butt  
 – Hardwood  
 – Weighted

**ALL-WOOD CUES ARE MADE OF FULLY KILN-DRIED WOODS**  
 \*\*\*\*\*  
**BEST PURCHASED IN CASE LOTS OF 36 PCS. INNER PACKS OF 12 PER BOX WITH STANDARD ASSORTED WEIGHTS**

B1833  
B1832  
B1831  
B1830

B3219  
B3220  
B3221  
B3222

**6880 South Emporia Street Centennial, Colorado 80112  
 303-790-0885 – 303-790-0746 – FAX  
 Toll-Free: 1-800-525-7059**

**e-mail: [game@amusemp.com](mailto:game@amusemp.com) – [www.amusementemporium.com](http://www.amusementemporium.com)**



# Bridge Sticks

Hardwood – 57" W/13 mm End

B0278 – All Brown “Mahogany”

B0279 – All Black

B0280 – Natural/Black

B1102 – Natural/Black; 2-Pc.



## Bridge Heads/Hooks



**B0050**  
Heavy-Duty Aluminum  
With Set Screw



**B0052**  
Heavy-Duty Bronze  
With Set Screw



**B0049** – Plastic



**B1432** – Nylon



**B0051** – Black

*Most Popular Selections Listed.  
Other Styles Available – Call  
Your Salesperson For Details*

6880 South Emporia Street Centennial, Colorado 80112  
303-790-0885 – 303-790-0746 – FAX  
Toll-Free: 1-800-525-7059

e-mail: [game@amusemp.com](mailto:game@amusemp.com) – [www.amusementemporium.com](http://www.amusementemporium.com)

# Composite Graphite And Fiberglass Cues

**BEST QUALITY  
AVAILABLE!**

## **Fiberglass 1-Piece Cues B3422 – 57" 13 mm**

**CUE FEATURES:**  
**8-Layers – Chip Resistant  
 Foam Core – Won't Warp**  
**4-Prong Look**  
**High-Impact Ferrule**  
**With Leather Tip**

**With  
Printed  
Weights**

\*\*\*\*\*

**18 oz. to 21 oz. Assorted Per Case.  
 24 Per Case, 12 Inner Box**

Also Available  
In 52", 48",  
42", and 36"



## **Graphite 1-Piece Cues 58" 13 mm**

**CUE FEATURES:**  
**8-Layers – Chip Resistant  
 Foam Core – Won't Warp**  
**PVC Wrap**  
**High-Impact Ferrule**  
**With Leather Tip**

\*\*\*\*\*

**18 oz. to 21 oz. Assorted Per Case.  
 24 Per Case, 12 Inner Box**

- B3519 – Black**
- B1859 – Blue**
- B1860 – Red**
- B1861 – Gray**
- B1862 – Green**



B3422

B3519

**6880 South Emporia Street Centennial, Colorado 80112**  
**303-790-0885 – 303-790-0746 – FAX**  
**Toll-Free: 1-800-525-7059**

**e-mail: [game@amusemp.com](mailto:game@amusemp.com) – [www.amusementemporium.com](http://www.amusementemporium.com)**

***Chalk***  
**USA-Made**



**Billiards**

<b>Color</b>	<b>Master Gross – Dz.</b>	<b>Silver Cup Gross – Dz.</b>	<b>Triangle Gross – Dz.</b>	<b>National Gross – Dz.</b>
<b>Blue</b>	<b>B0102 – B0108</b>	<b>B1461 – B1463</b>	<b>B0090 – B0096</b>	<b>B0114 – B0119</b>
<b>Green</b>	<b>B0103 – B0109</b>	<b>B1462 – B1464</b>	<b>B0091 – B0097</b>	<b>B0115 – B0120</b>
<b>Red</b>	<b>B0104 – B0110</b>	<b>– B1466</b>	<b>B0092 – B0098</b>	<b>B0116</b>
<b>Gold</b>	<b>B0105 – B0111</b>		<b>B0093</b>	
<b>Rust</b>	<b>– B0112</b>			
<b>Brown</b>	<b>– B0113</b>	<b>– B1474</b>		
<b>Black</b>	<b>– B0107</b>	<b>– B1470</b>		
<b>Burgundy</b>		<b>B1815 – B3450</b>		<b>B1580</b>
<b>Wine</b>		<b>– B1465</b>		
<b>Spruce</b>		<b>– B1562</b>		

**Most Popular Selections Listed. All Colors Stocked – Call For Information  
(5-Gross Per Case)**

**Amusement Emporium Chalk**

**Sold In 144 Lots Only In Packages of 12/Box.**

**Blue – B0124**

**Green – B3569**



**(6-Gross Per Case)**

**6880 South Emporia Street Centennial, Colorado 80112  
303-790-0885 – 303-790-0746 – FAX  
Toll-Free: 1-800-525-7059**

**e-mail: [game@amusemp.com](mailto:game@amusemp.com) – [www.amusementemporium.com](http://www.amusementemporium.com)**

**Cone Chalk**



**B0160 – Master**  
(Sold In Case Lots Of Six)



**B1460 – Silver Cup**



**B0165– Talcum Powder**  
**13 oz. Can**

**Cone Chalk Holders**



**B0773– Metal**  
**Bracket With Wood**  
**Platform/Dowel**



**B0161– All Wood**  
**With Screws**



**B1765– All Metal**  
**Heavy Duty**

**Chalk Grips**



**B0127 – Red Rubber**  
**With Cord**



**B3568 – Black Rubber**  
**With Cord**



**B0129 – Deluxe Black**  
**Rubber Covered Metal**  
**With Cord**

**6880 South Emporia Street Centennial, Colorado 80112**  
**303-790-0885 – 303-790-0746 – FAX**  
**Toll-Free: 1-800-525-7059**

**e-mail: [game@amusemp.com](mailto:game@amusemp.com) – [www.amusementemporium.com](http://www.amusementemporium.com)**

# Cue Tip Repair Products



**B0637 – Deluxe Repair Kit**  
Includes: Cue Top Sander, Clamp,  
Chalk, Glue, Trimmer, and Tips.



**B0211 – Standard Repair Kit**  
Includes: Chalk, S/O and S/I Tips. Clamp,  
Ferrules, Trimmer, and Glue.

## American Made!



**B0220 – Deluxe Cue  
Top Sander**  
Used To Sand Cue Tops For  
Proper Glue Tip Application.

**B1836 – Replacement  
Sandpaper Disks For  
B0220**



**B0221 – Tenoning Machine**  
Used To Cut Dowels And Ferrules  
**B0223 – Set Of Blades**  
**B0225 – Spring**

**9" Trimmers W/Sandpaper**  
**B0215 – Deluxe Metal**  
**B0219 – Standard Metal**  
**B0217 – Plastic**  
**Sandpaper Refills**

**B0218 – Refills For Standard/Plastic**  
**B1835 – Refills For Deluxe**

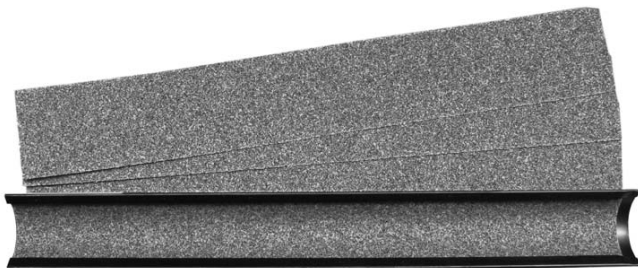





**6880 South Emporia Street Centennial, Colorado 80112**  
**303-790-0885 – 303-790-0746 – FAX**  
**Toll-Free: 1-800-525-7059**

**e-mail: [game@amusemp.com](mailto:game@amusemp.com) – [www.amusementemporium.com](http://www.amusementemporium.com)**

# AMUSEMENT EMPORIUM<sup>TM</sup> Inc.

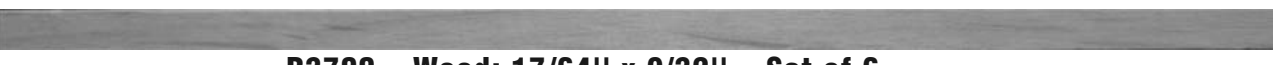
## Cushion Rubber

### Feather Strips for "Home-Style" Tables

	
	B3700 – Wood; 17/64" x 9/32" – Set of 6
	
	B3624 – Rubber; 1/4" x 1/4" – Roll of 100'
	
	B3654 – Rubber; 1/4" x 3/8" -- Roll of 100'

### Top Quality – Pure Gum Rubber W/Canvas Backing Sold In Sets Of 6

-  B1255
-  B1493
-  B1494
-  B1494
-  B1071
-  B1072
-  B1293

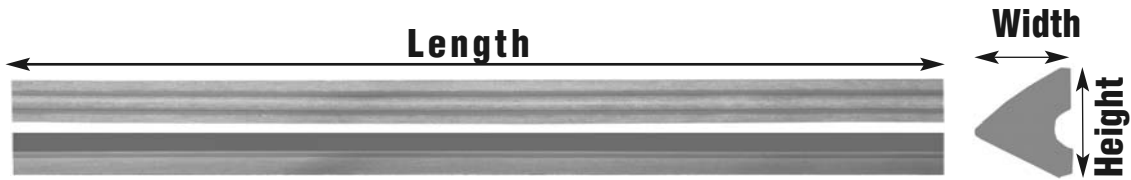

Stock#	Length	Type	H	W
B1255	119"	K55	1.272"	1.031"
B1493	43"	K55	1.272"	1.031"
B1494	49"	K55	1.272"	1.031"
B1071	43"	K66	1.177"	0.968"
B1072	49"	K66	1.177"	0.968"
B1293	43"	U23	1.109"	0.906"
B1763 - Century	41"	K44	1.272"	0.748"
B1996 - Brunswick SS	47"	K55	1.272"	1.031"
B1569	36"	#818	0.985"	0.070"

-  B1763
-  B1996
-  B1569



**B0152**  
Cushion Facings  
Rubber And Cloth – Set Of 12

**6880 South Emporia Street Centennial, Colorado 80112**  
**303-790-0885 – 303-790-0746 – FAX**  
**Toll-Free: 1-800-525-7059**

**e-mail: [game@amusemp.com](mailto:game@amusemp.com) – [www.amusementemporium.com](http://www.amusementemporium.com)**

**Soft Rubber Pocket Liners**  
**And Gulley Boots**

**3" Liners**

**B0515 – Complete Set**  
**B0513 – Corners Only**



**4" Liners**

**B0516 – Complete Set**

**B0844 – O/S**  
**Full Set – Valley**

**B1695 – O/S**  
**Corners Only**  
**(Requires Nails)**



**B0853 – Valley N/S Full**  
**Set – W/Holes**

**B3660 – Valley N/S**  
**Corners Only – W/Holes**  
**(Requires Screw and**  
**Washer Below)**



**C0395 – Screw**  
**Nail For Pockets**



**B1354**  
**Dynamo**  
**Push Locks**



**Screw**  
**B0854**

**Washer**  
**B0855**

**Gulley Boots**  
**Valley-Style**



**B0517**  
**Soft Rubber**  
**B1847**  
**Hard Plastic**

**Soft Rubber**  
**Drop Pockets**



**B0510 – Web**

**(9" Depth)**



**B0511 – Solid**

**Pocket Liners, Gulley Boots, And Drop Pockets Are Sold In Sets Of Six.**  
**All Items Black In Color**

**6880 South Emporia Street Centennial, Colorado 80112**  
**303-790-0885 – 303-790-0746 – FAX**  
**Toll-Free: 1-800-525-7059**

**e-mail: [game@amusemp.com](mailto:game@amusemp.com) – [www.amusementemporium.com](http://www.amusementemporium.com)**

AMUSEMENT EMPORIUM<sup>TM</sup> Inc.

Triangles - 2-1/4"

Plastic



B0585 - Black



B0575 - Black 9-Ball

PVC

Nearly Indestructible



B3566 - Black  
B3567 - Brown



B3661 - Black 9-Ball

Hardwood



B0576 - Standard, Doweled  
B0577 - Brass Corner Straps

6880 South Emporia Street Centennial, Colorado 80112  
303-790-0885 - 303-790-0746 - FAX  
Toll-Free: 1-800-525-7059

e-mail: [game@amusemp.com](mailto:game@amusemp.com) - [www.amusementemporium.com](http://www.amusementemporium.com)



## Cue Racks

### Wall Mount



**B0312**  
**Economy 6-Cue Wall**  
**Rack, Mahogany Stain**  
**With Plastic Clips**

### Ideal Location Rack



**Mahogany Stained**  
**Provincial Wall Rack**  
**With Plastic Clips**

**B0317 – 6-Cue**  
**B0318 – 8-Cue**  
**B0319 – 12-Cue**

**These Racks Are Available In Various**  
**Stains and Styles...Ask Your Salesperson**

## Cue Clips



**B0228**  
**Small Plastic**



**B0229**  
**Metal W/ Nylon**  
**Rollers**



**B1611**  
**Metal W/Nylon**  
**Rollers**



**Nylon**  
**B1612– White**  
**B3712 – Black**



**B1737**  
**Large Plastic**

**B3711**  
**Plastic – For**  
**B0317**



**6880 South Emporia Street Centennial, Colorado 80112**  
**303-790-0885 – 303-790-0746 – FAX**  
**Toll-Free: 1-800-525-7059**

**e-mail: [game@amusemp.com](mailto:game@amusemp.com) – [www.amusementemporium.com](http://www.amusementemporium.com)**

**Floor Stands**

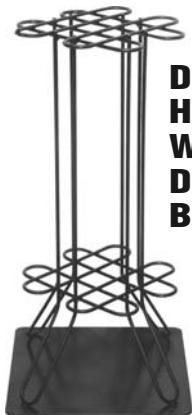

**Dimensions:**  
H – 24"  
W – 11-7/8"  
Depth – 11-7/8"  
Base – 1/2"

**SOLID ONE-PIECE WELDED CONSTRUCTION**

**B3487 – Heavy-Duty, Black, All Metal Holds 17 Cues**



**Dimensions:**  
H – 14-9/16"  
Dia. – 10"

**\*B3074 Round Metal Gray/Chrome**



**Dimensions:**  
H – 22"  
W – 14-1/2"  
L – 16"

**\*B1852 – Light  
\*B1853 – Dark  
Corner Wood. Holds 8 Cues  
W/Drink and Ball Areas**



**\*B0335 – All Metal Wire Cue Rack. Holds 48 Cues**

**Many Other Styles Available  
Ask Your Sales Professional**



**Dimensions:**  
H – 20-1/4"  
Dia. – 12-3/4"

**\*B3562 – Mahogany  
\*B3563 – Oak  
8-Cue All Wood**

**\*Assembly Required**



**\*B3564  
All Wood, Dark Brown  
Holds 36 Cues**

**6880 South Emporia Street Centennial, Colorado 80112  
303-790-0885 – 303-790-0746 – FAX  
Toll-Free: 1-800-525-7059**

**e-mail: [game@amusemp.com](mailto:game@amusemp.com) – [www.amusementemporium.com](http://www.amusementemporium.com)**

**Table Covers**

**Fitted, Heavy-Duty Vinyl With  
Double-Stitched Seams**

**Billiards**

**For 7' With 4" Rails\***  
**Stock# B3488**



\*Rail Width Of 4"

**For 8' With 4" Rails\***

<b>Stock#</b>	<b>Color</b>
<b>B0920</b>	<b>Brown</b>
<b>B0922</b>	<b>Blue</b>
<b>B0924</b>	<b>Black</b>
<b>B0929</b>	<b>Burgundy</b>
<b>B0940</b>	<b>Tan</b>

**Sold By Table And Rail Sizes. Other Sizes Available  
in Brown, Blue, Black, Burgundy and Tan**

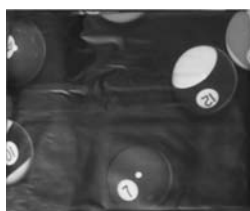

**- Vinyl -  
In Hanging Bags With Eyelets  
And Weighted Corners**

	<b>For 7' Tables</b>	<b>For 8' Tables</b>	<b>For 9' Tables</b>
<b>"Clear"</b>	<b>B3119</b>	<b>B0088</b>	<b>B0086</b>
<b>Green</b>	<b>B3444</b>	<b>B0082</b>	<b>B0087</b>
<b>Brown</b>	<b>B3120</b>	<b>B0772</b>	<b>B1284</b>
<b>Burgundy</b>	<b>B3121</b>	<b>B1777</b>	<b>B1778</b>
<b>Black</b>	<b>B3122</b>	<b>B1431</b>	<b>B1434</b>
<b>Blue</b>	-	<b>B0829</b>	<b>B0085</b>
<b>Gray</b>	-	<b>B1349</b>	<b>B1350</b>
<b>Red</b>	-	<b>B0080</b>	<b>B0083</b>
<b>Blue "Balls"</b>		<b>B3036</b>	<b>B3037</b>



**Vinyl Cover With Elastic  
Edge Band For 7' - 9' Tables**

<b>Brown</b>	<b>B0078</b>
<b>Green</b>	<b>B3573</b>
<b>"Clear"</b>	<b>B3574</b>

**B0079 - Monte Carlo**

**Vinyl With  
Dice Layout  
On One Side**



**6880 South Emporia Street Centennial, Colorado 80112  
303-790-0885 - 303-790-0746 - FAX  
Toll-Free: 1-800-525-7059**

**e-mail: [game@amusemp.com](mailto:game@amusemp.com) - [www.amusementemporium.com](http://www.amusementemporium.com)**

# AMUSEMENT EMPORIUM<sup>TM</sup> Inc.

## Tips And Ferrules

### Slip-On



#### Top Quality (Taiwan)

White Plastic With  
Soft Blue-Gray Tip

<b>B0446</b>	<b>11</b>
<b>B0718</b>	<b>11.5</b>
<b>B0447</b>	<b>12</b>
<b>B0448</b>	<b>12.5</b>
<b>B0449</b>	<b>13</b>
<b>B0719</b>	<b>13.5</b>
<b>B0450</b>	<b>14</b>

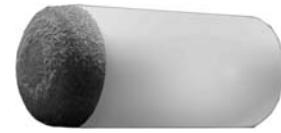

#### Superior Quality (Italian)

White Plastic With  
Brown Hard Tip

<b>B0792</b>
<b>B0793</b>
<b>B0794</b>
<b>B0795</b>
<b>B0796</b>
<b>B0797</b>
<b>B0798</b>

### Taiwan Tips – 100 Pc Assortment

<p><b>Stock# B0445</b></p> <p><b>Includes:</b></p> <p>5 ea. 11.5 mm</p> <p>5 ea. 13.5 mm</p> <p>25 ea. 12 mm</p> <p>30 ea. 12.5 mm</p> <p>35 ea. 13 mm</p> <p><b>Individually Bagged By Size</b></p>	<p><b>Stock# B3730</b></p> <p><b>Includes:</b></p> <p>5 ea. 11 mm</p> <p>10 ea. 11.5 mm</p> <p>25 ea. 12 mm</p> <p>25 ea. 12.5 mm</p> <p>25 ea. 13 mm</p> <p>5 ea. 13.5 mm</p> <p>5 ea. 14 mm</p> <p><b>Sizes Marked. Supplied In a Clear-Top Box</b></p>
--	---

### Screw-In

Size	Tip	Ferrule
12 mm	<b>B0403</b>	<b>B0410</b>
13 mm	<b>B1282</b>	<b>B1283</b>

**Soft Blue-Gray Tip  
With Brass Screw**



**B1299 Tip Gauge**

### Cue Tip Sizing Guide (mm)

Place Tip Here To Determine Size

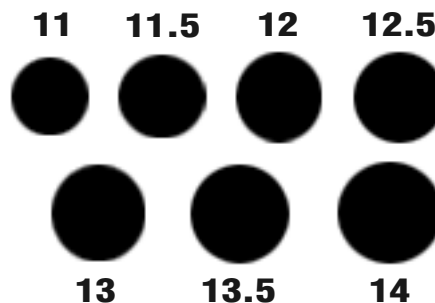

**6880 South Emporia Street Centennial, Colorado 80112**

**303-790-0885 – 303-790-0746 – FAX**

**Toll-Free: 1-800-525-7059**

**e-mail: [game@amusemp.com](mailto:game@amusemp.com) – [www.amusementemporium.com](http://www.amusementemporium.com)**

**Tips And Ferrules**

**Fiber Ferrules**

**13 mm**  
**5/16" X 3/4"**  
**B3408**



**13.5 mm**  
**5/16" X 1"**  
**B3671**

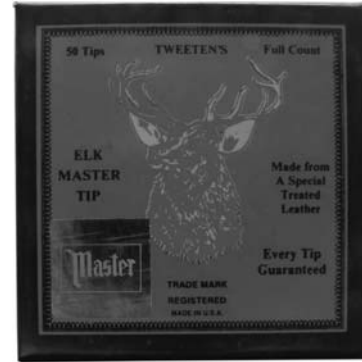

**Glue-On Tips**

Size (mm)	Royal Oak	Blue Knight	Elk Master	Le Professional
11			<b>B0374</b>	<b>B0397</b>
12	<b>B0383</b>	<b>B0351</b>	<b>B0375</b>	<b>B0398</b>
12.5			<b>B0368</b>	<b>B3072</b>
13	<b>B0384</b>	<b>B0352</b>	<b>B0376</b>	<b>B0399</b>
13.5			<b>B0373</b>	
14	<b>B0385</b>	<b>B0353</b>	<b>B0377</b>	<b>B0400</b>
Asst.	<b>B0386</b>	<b>B0354</b>	<b>B0378</b>	

**Sold In Boxes Of 50**

***Blue Knight And Elk Master Tips Are Pre-chalked. Le Professional Tips Are Tanned To A Hard Finish For Professional Players***

**Other Styles Available**

**Cue Tip Clamps**



**B0199**  
**Plastic With Rubber Band**



**B0201**  
**Aluminum With Leather Tab**



**B0200**  
**Aluminum**



**B0202**  
**Bronze With Leather Tab**

**6880 South Emporia Street Centennial, Colorado 80112**  
**303-790-0885 - 303-790-0746 - FAX**  
**Toll-Free: 1-800-525-7059**

**e-mail: [game@amusemp.com](mailto:game@amusemp.com) - [www.amusementemporium.com](http://www.amusementemporium.com)**

**AMUSEMENT EMPORIUM<sup>TM</sup> Inc.**

**Tip Glues**



**TWEETEN'S TEN MINUTE CEMENT**

**B0195 – 1 oz.  
B0196 – 2 oz.**



**B3094 – 3 gm.  
Cyanoacrylate  
Instant Bond – Gel**



**B3640 – 3 gm.  
Loctite Instant  
Adhesive**

**Cue Bumpers**

**B3735  
Screw for  
B0203**



**Rubber**



**B0203  
Standard  
(Mounts With  
Screw)**



**B3535  
Deluxe  
(Valley  
Style)**



**B0768  
Deluxe  
W/Plug  
(Valley Style)**



**B2100 – Threaded  
Bumper For Our  
Fiberglass Cue  
(B3422)**

**Slip-On**



**B0601 – Black  
B3570 – Lt. Red  
2-3/4" Long**

**Other Styles Available – Ask Your Sales Rep**

**Self-Adhesive Spots – 1-1/4"**

**On Rolls**



**B0477  
Economy  
100 Per Roll**



**AE Brand  
B1420 – USA  
Made  
100 Per Roll**



**B3181  
"Championship"  
250 Per Roll**



**B0843  
Valley  
"Cougar"  
100 Per Roll**

**In Tins**



**B0476  
Master  
"Tefco"  
12 Per Tin**

**6880 South Emporia Street Centennial, Colorado 80112  
303-790-0885 – 303-790-0746 – FAX  
Toll-Free: 1-800-525-7059**

**e-mail: game@amusemp.com – www.amusementemporium.com**

**AE Brand  
SAVE!!**

**Adhesives**

**3M Brand**



**B1145  
American Made  
17 Oz. Can**



**D0001  
#74 Foam  
16.9 Oz. Can**



**D0003  
#76  
Adjustable Spray  
18.1 Oz. Can**



**D0004  
#77 Quick Set  
16.75 Oz. Can**

**Contact Cement**



**D0002  
Fastbond 12  
Solvent Base  
Quart**



**D0010  
Fastbond 30  
Water Base  
Quart**

**Barge Cement**



**D0400 – 3/4 oz.  
D0401 – 2 oz.  
D0403 – Quart  
D0404 – Gallon  
D0405 – Thinner, Quart**

**6880 South Emporia Street Centennial, Colorado 80112  
303-790-0885 - 303-790-0746 - FAX  
Toll-Free: 1-800-525-7059**

**e-mail: [game@amusementemporium.com](mailto:game@amusementemporium.com) - [www.amusementemporium.com](http://www.amusementemporium.com)**

# AMUSEMENT EMPORIUM<sup>TM</sup> Inc.

## Table Movers/Lifts

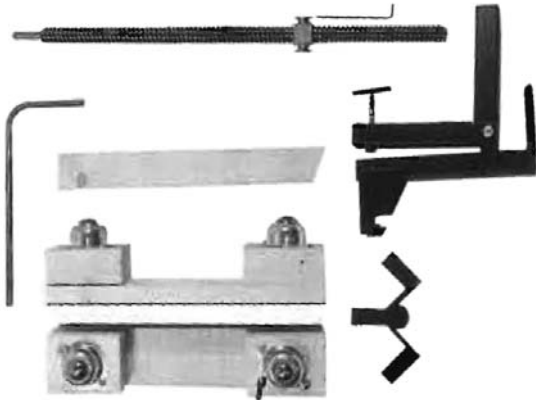

### B3738 – Slate Lifter Kit

- Safely Lifts And Rotates The Slate To Come To You While Recovering
- Allows 1 Person To Recover A Pool Table
- Simple, But Clever, Design Makes This Kit Very Easy To Use
- Includes Instructional Video Tape If Further Instruction Is Necessary



### B3737 – Pool Table Mini-Mover

- Adjusts Easily For Different Widths And Lengths
- Fits Virtually All Pool Tables And Air Hockey Tables, Even Those With Trussle Legs
- Two Will Fit Side By Side In A Pickup Truck
- Both The Mover And Pool Table Can Fit On An Extended Pickup Lift Gate
- Strong Clamps Hold Table Securely In Place
- Rated At 1000 Lb. Test
- Specially Angled To Balance Load Over Wheels
- Built In The USA
- Size: 35" X 22" X 12"; Weighs 42 Lbs.



### X5451

### EZ-Lift Pool Table Mover

The Easy To Use Pool Table Lift Used At Thousands Of Locations Worldwide. Designed For Moving Pool Tables At Bars Or Taverns To Make Room For Band Nights Or Other Special Events. To Use, Simply Roll The Pool Table Lift Under The Pool Table, Push Down On The Handle (Not Shown) To Raise The Table, Insert Locking Pin, And Roll The Table To Its New Location



### X5452

### U-Lift Pool Table Mover

1-Person Mover For Pool Tables, Air Hockey And Foosball Games  
UPS/FedEx Shippable

6880 South Emporia Street Centennial, Colorado 80112  
303-790-0885 – 303-790-0746 – FAX  
Toll-Free: 1-800-525-7059

e-mail: [game@amusemp.com](mailto:game@amusemp.com) – [www.amusementemporium.com](http://www.amusementemporium.com)



**Leg Levelers**

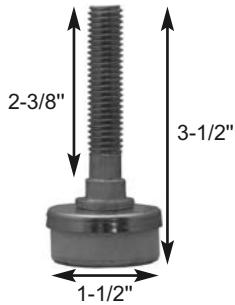

**B0534**  
**Heavy-Duty**  
**Rigid W/Rubber**  
**Base Bolt Dia.**  
**Is 1/2" x 13**

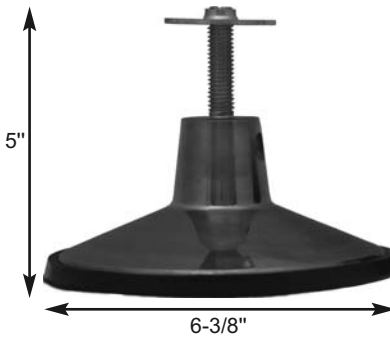

**B0533**  
**Polished Cast Aluminum**  
**W/Rubber Trim. Bolt**  
**Dia. Is 1/2" x 13**  
**Includes Nut (B0535)**

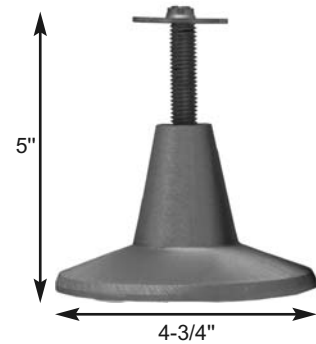

**B3018**  
**Solid Brushed**  
**Aluminum. Bolt**  
**Dia. Is 1/2" x 13**  
**Includes Nut (B0535)**



**B0535 - T-Nut For**  
**B0533/34 And**  
**B3018.**  
**Hole Dia. is 1/2" x 13**

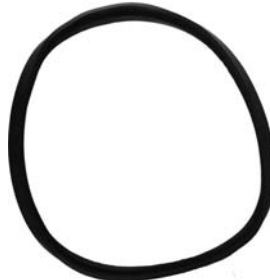

**B3585**  
**Rubber Ring**  
**For B0533**



**B1828**  
**Valley Leg-leveler**  
**Adjusting Plate**

**6880 South Emporia Street Centennial, Colorado 80112**  
**303-790-0885 - 303-790-0746 - FAX**  
**Toll-Free: 1-800-525-7059**

**e-mail: [game@amusemp.com](mailto:game@amusemp.com) - [www.amusementemporium.com](http://www.amusementemporium.com)**



## **Valley Cue Balls**

### **Magnetic 2-1/4"**

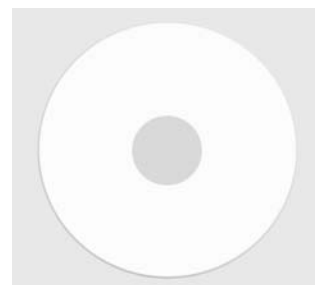

**Original – Belgian  
Cage – “Cats Eye”**  
B0030 – #1 Quality  
B0027 – #2 Quality

**USA**  
**Metal Flake (Mudball)**  
B0789

**Oriental**  
B0781

**New-Style Belgian**  
B3207 – Green “S”  
B3521 – Green “S”/Cougar  
B1733 – Green Dot; Magnetic/  
Weighted

B3008  
Green Dot

B1016 – 2-3/8" – Non-Magnetic

B1718

---

---

## **Valley Supreme Cues**

### **57" Length, 1-Piece**



B0300 – 15 - 17 Oz.  
B0301 – 18 - 21 Oz.

6880 South Emporia Street Centennial, Colorado 80112  
303-790-0885 – 303-790-0746 – FAX  
Toll-Free: 1-800-525-7059

e-mail: [game@amusemp.com](mailto:game@amusemp.com) – [www.amusementemporium.com](http://www.amusementemporium.com)



## Replacement Rails

Size	Rail Length (Approx.)		Covered	Uncovered
	End	Side		
6' 36" X 72" PS	34-3/4"	34"	B0613*	B3674
7' 40" X 80" PS	36-1/2"	36-1/4"	B0614*	B3542
7' 40" X 80" PS	36-1/2"	36-1/4"		B1947*
<i>An AE</i>				
7' 40" X 80" PS	36-1-2"	36-1/4"	<i>Exclusive Item</i>	B3255
8' 44" X 88" PS	41"	40-1/2"	B0615*	B3284* B3586



\*Genuine Valley

## Locks and Keys

Number	Key Only	Key & Lock	Description
1155	B0767		
2255	B0766	B0765 – 7/8"	Double Bitted
C512	B0764	B0763 – 1-1/8"	Single Bitted
54	B1882	B0769 – 1-1/8"	Single Bitted
7515		B3705 – 1-1/8"	Double Bitted



*Locks Include All Hardware*

## Coin Chute Ends

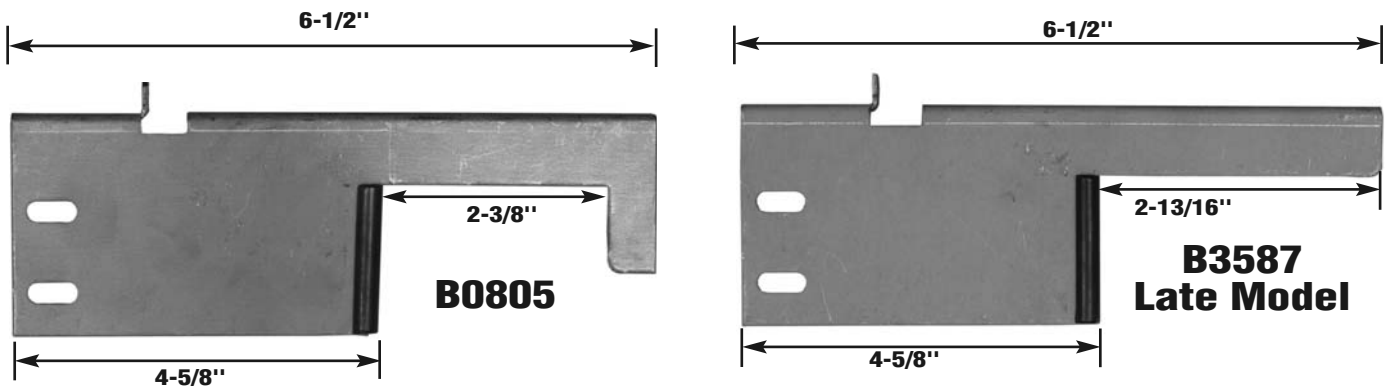

6880 South Emporia Street Centennial, Colorado 80112  
 303-790-0885 - 303-790-0746 - FAX  
 Toll-Free: 1-800-525-7059

e-mail: [game@amusemp.com](mailto:game@amusemp.com) - [www.amusementemporium.com](http://www.amusementemporium.com)

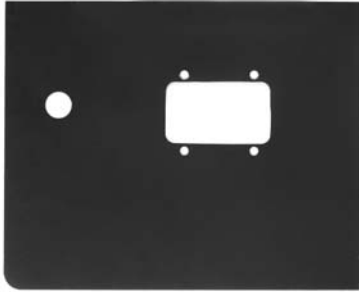

**B0831**  
Cash Box Door – Black  
8-1/4" X 10-3/16"



**Hardware**



**B1917**  
Shoulder Bolt



**B0840**  
Push Chute Trap



**B3286 – Ball View Door**  
Jewel/Mahogany

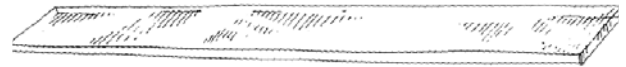

**Plexiglass for Ball Viewer Door**  
**B0782 – 4-5/8" X 32-1/8" X 1/8"**  
**B1435 – 3-5/8" X 32-1/2" X 1/8"**



**B0846**  
Rubber Ball Drop Mat

**Clean-out Doors**



**B3722 – Jewel Mahogany**  
**B3723 – Graphite**



**B0826**  
Hinge Bar  
Roller

**C0355**  
3/8" "E" Clip



**B3129**  
Hinge Bar



**B0843**  
Valley "Cougar"  
Table Spots  
100 Per Roll

**Hinge Bar Block**  
**B3276 – Lower**  
**B3277 – Upper**



**6880 South Emporia Street Centennial, Colorado 80112**  
**303-790-0885 – 303-790-0746 – FAX**  
**Toll-Free: 1-800-525-7059**

**e-mail: [game@amusemp.com](mailto:game@amusemp.com) – [www.amusementemporium.com](http://www.amusementemporium.com)**



**Hardware**



**10285 Mechanical Counter W/Advance Lever**



**B0640 Rail Screw  
1/4" X 20 X 4-1/2"**



**B0845 Leg Bolt**



**B0780 Rail T-Nut**



**B0859 – Meter Spring**



**B0618 – Hinge Bar Spring**

**Trim**



**B0804 Cash Box (Plastic)**



**B0834 – Coin Chute  
B0841 – Ball Drop  
B0842 – Triangle (Shown)  
B0847 – Cue Ball Ring  
B2003 – Ball View Door**



**B0809 Fiberglass Leg**



**B1827 Leg Leveler**



**B1828 Leg Leveler Adjusting Plate (For B1827)**



**B1459 Table Magnet**



**B0762 Ball Shunt**



**B3274 Top Rail Corner**

**6880 South Emporia Street Centennial, Colorado 80112  
303-790-0885 – 303-790-0746 – FAX  
Toll-Free: 1-800-525-7059**

**e-mail: [game@amusemp.com](mailto:game@amusemp.com) – [www.amusementemporium.com](http://www.amusementemporium.com)**



**Hardware**



**B3588  
Trim Molding  
Screw**



**Molding  
End View**



Table Size	End Rail	Length	Side Rail	Length
7'	B0851	33-3/4"	B0852	73-3/4"
8'	B3651	38-1/4"	B3652	82-1/4"

**Pocket Liners**



**Old Style  
Uses Nails (Below)  
B0844 – Full Set  
B1695 – Corners Only**



**New Style With Holes Uses  
Screws And Washers (Below)  
B0853 – Full Set  
B3660 – Corners Only**



**C0395  
Pocket Liner  
Screw Nails  
For Above  
3/4" x #6**

**New Style  
Valley Pocket Liner  
Screw — Washer  
B0854 — B0855**



**6880 South Emporia Street Centennial, Colorado 80112  
303-790-0885 - 303-790-0746 - FAX  
Toll-Free: 1-800-525-7059**

**e-mail: [game@amusemp.com](mailto:game@amusemp.com) - [www.amusementemporium.com](http://www.amusementemporium.com)**



**Genuine Rail Sets**

**Genuine Belgian Cue Balls**

Table Size	Covered	Uncovered
7'	B1625	B3285
8'	B1918	

**Orange Dot Cue Balls**  
#1 – B0031  
#2 – B0026



**B1417**  
Plastic Cash Box



**B3070 – #106 Lock & Key**  
**B3071 – #106 Key Only**



**B1354**  
Push Locks



**B1386**  
Coin Door Frame

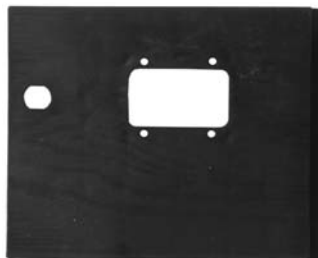

**B1387**  
Plastic Coin Door



**B2123**  
Fiberglass  
Table Leg



**B1384**  
Tripper Rod



**B3724 – Black**  
Clean-out Door



**B3161 - Black Ball View Door**

**6880 South Emporia Street Centennial, Colorado 80112**  
**303-790-0885 – 303-790-0746 – FAX**  
**Toll-Free: 1-800-525-7059**

**e-mail: game@amusemp.com – www.amusementemporium.com**

**Lamps/Shades**

**Brass Bar Lamps  
W/Poly Shades**



Stock#	Style	Length
B3643	Single Shade	14"
B3644	Double Shade	28"
B3645	Triple Shade	48"
B3646	Quad Shade	68"

**Comes With Green Poly  
Shades And Hardware**



**Metal Shade Brass Bar Lamps  
(Includes All Hardware)**

Stock#	Style	Length
B3740	Single Light W/Green Metal Shade	15"
B3741	Dual Light W/Green Metal Shade	52"
B3696	Triple Light W/Green Metal Shade	60"
B3742	4-Light W/Green Metal Shade	72"

**Replacement Metal Shades For Stock#'s  
B3740, 41, 42, and B3696**

Shade Stock#	Color
B3697	Green
B3698	Red
B3699	Black

**B3743 Triple Light W/Brass Metal Shade - 60"  
B3744 Shade For B3743**

**Replacement Shades for B3643 – 6  
B1535 – Green Poly  
B1823 – Black Poly  
B1825 – Brass  
B1876 – Green Poly, Ribbed**



**Overhead Shade**



**B0492**

**Fiberglass Overhead  
Shade Holds Two  
Incandescent Lamps  
48-1/2" Long  
18-3/4" Wide  
8-1/2" High  
(Wiring Harness  
Sold Separately)**

**Wiring Harness  
Kits**

**Wiring Harness Kits  
B0508 – Single Lamp  
B0509 – Double Lamp  
B1065 – Triple Lamp  
Includes: Chain, Socket(s)  
Wire/plug, Washers, Lag  
Bolts, and Hooks**

**6880 South Emporia Street Centennial, Colorado 80112  
303-790-0885 – 303-790-0746 – FAX  
Toll-Free: 1-800-525-7059**

**e-mail: game@amusemp.com – www.amusementemporium.com**



**Cleaners/Maintenance**

**Billiards**



**B0623**  
Razor Blades  
Individually Wrapped



**Beeswax**  
**B0555 1-oz.**  
**B0553 1-lb.**  
Pure Yellow  
Beeswax For  
Slate Seams and  
Scratches



**B1583**  
Table Cloth  
Spot Remover  
W/Pump Sprayer



**B3509**  
Quick Clean  
Cloth Cleaner  
Aerosol – 18-Oz.

**Bumper Pool Parts**

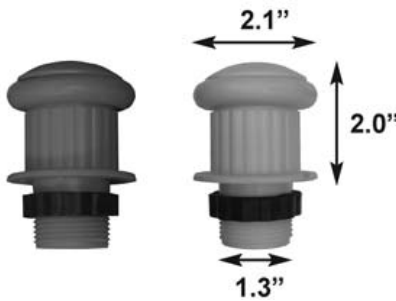

**B0063 – Jumbo Plastic Bumpers. Set Includes Six Red and Six White. With Nuts**

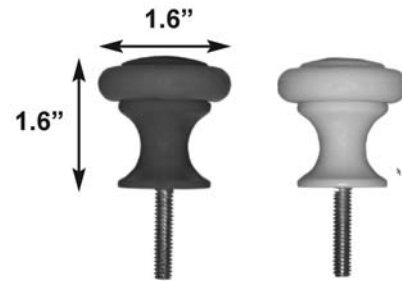

**B4202 – Small Plastic Bumpers. Set Includes Six Red and Six White.**

**Jumbo Rubber Bumper Rings**  
**B0061 – Red**  
**B0062 – White**

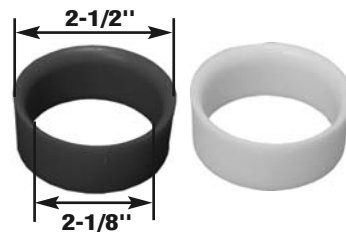
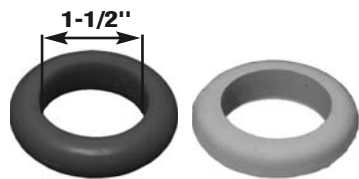

**Hole Liners For 2-1/8" Balls**  
**B0066 – Red**  
**B0067 – White**

6880 South Emporia Street Centennial, Colorado 80112  
303-790-0885 – 303-790-0746 – FAX  
Toll-Free: 1-800-525-7059

e-mail: [game@amusemp.com](mailto:game@amusemp.com) – [www.amusementemporium.com](http://www.amusementemporium.com)

***Amusement/Coin-Op Accessories***

**Pea Bottles**



- B0568 – Red Plastic, Economy**
- B0569 – Leather**
- B0570 – Brown Plastic**

**Peas**



- B0571 – White W/Red Numbers**
- B0572 – Red W/White Numbers**
- B1059 – Wood**
- B1069 – Black W/White Numbers**

(All Peas Sets Sold In Boxes)



- B1055  
Bumper Tubes  
Set Of Six  
Standard  
Green Color**



**X5550 – Coin/Token Holder**

**Coin Holder Will Hold Up To Eight Coins/Tokens To Establish The Player Rotation. Eliminates Conflicts Over Player Position In The Rotation. Mounts Easily With Included Adhesive Strip**

***WE ARE DEDICATED TO  
SUPPLING THE BEST  
QUALITY PARTS AT THE  
BEST PRICE, FROM AN  
INVENTORY WITH A 95%  
PARTS STOCK LEVEL***

**6880 South Emporia Street Centennial, Colorado 80112  
303-790-0885 – 303-790-0746 – FAX  
Toll-Free: 1-800-525-7059**

**e-mail: [game@amusemp.com](mailto:game@amusemp.com) – [www.amusementemporium.com](http://www.amusementemporium.com)**



## Cloth



**Tour Edition Worsted**  
**24 oz., 70%/30% – 66"**  
**#3030 – Unbacked**  
**B1950-31 – Championship**  
**Green**



**Titan**  
**21 oz., 75%/25% – 66" – Unbacked**  
**B2001-00; Basic Green**  
**B2050-62; Burgundy**  
**B2052-43; Electric Blue**  
**B2058-35; Red**  
**B2060-77; Black**  
**B2063-32; Dark Green**  
**B3360-31; Tournament Green**

***Most Popular Colors Listed***  
***Available in over 20 Colors!!!***

**6880 South Emporia Street Centennial, Colorado 80112**  
**303-790-0885 – 303-790-0746 – FAX**  
**Toll-Free: 1-800-525-7059**

**e-mail: [game@amusemp.com](mailto:game@amusemp.com) – [www.amusementemporium.com](http://www.amusementemporium.com)**



**Cloth**



Looks, Feels  
And Plays Like  
A Worsted But  
At A Lower Cost



**Mercury/Ultra**

**19 - 20 oz. 75%/25% - 66"**

**"Mock" Worsted #3045 - Unbacked**

**B1893 - Tournament Green**

**#3046 Backed**

**B1998 - Tournament Green Backed**

**B3439 - Electric Blue, (7' Bed and Rails - Pre-Cut)**

**B3483 - Tournament Green (7' Bed and Rails - Pre-Cut)**

**B3484 - Tournament Green (8' Bed and Rails - Pre-Cut)**

*The Most Common  
Cloth Found In The  
Coin-Op Business*



**Invitational**

**20 - 21 oz. 75%/25% - 66"**

**#3066 - Unbacked**

**B1800 - Basic Green**

**B1900 - Basic Green (7' Bed and Rails - Pre-Cut)**

**B1901 - Basic Green (8' Bed and Rails - Pre-Cut)**

**B2047 - Dark Green**

**B2048 - Spruce**

**B2061 - Blue**

**#3074 - Backed**

**B1949 - Basic Green**

**B1697 - Basic Green (7' Bed & Rails - 6-Package - Pre-Cut)**

**B1819 - Basic Green (7' Bed & Rails - Pre-Cut)**

**B1698 - Basic Green (8' Bed & Rails - Pre-Cut)**

**6880 South Emporia Street Centennial, Colorado 80112**

**303-790-0885 - 303-790-0746 - FAX**

**Toll-Free: 1-800-525-7059**

**e-mail: [game@amusemp.com](mailto:game@amusemp.com) - [www.amusementemporium.com](http://www.amusementemporium.com)**

**Cloth**



**Mercury Ultra With Teflon  
19 - 20 oz. 75%/25% - 66"**

**#4045 - Unbacked**

**B3192 - Tournament Green**

**B3265 - Tournament Green (7' Bed & Rails - Pre-Cut)**

**B3266 - Tournament Green (8' Bed & Rails - Pre-Cut)**

**#4046 - Backed**

**B3193 - Tournament Green**

**B3259 - Tournament Green (7' Bed & Rails - Pre-Cut)**

**B3260 - Tournament Green (8' Bed & Rails - Pre-Cut)**

*Mercury Ultra Cloth Has Teflon  
Added Before Weaving  
A TRUE Liquid Resistant Fabric*



**Saturn II**

**19 - 20 oz. 75%/25% - 66"**

**#2066**

**B3657 - Unbacked; Basic Green**

**AE/CL - Economy, Backed Cloth  
19 - 20 oz. 75%/25% - 66"  
B3704 - Backed, Basic Green**

**6880 South Emporia Street Centennial, Colorado 80112**

**303-790-0885 - 303-790-0746 - FAX**

**Toll-Free: 1-800-525-7059**

**e-mail: [game@amusemp.com](mailto:game@amusemp.com) - [www.amusementemporium.com](http://www.amusementemporium.com)**



**Cloth**



**True Worsted – Used  
Worldwide In Tournament Play  
Yellow-Green Color**

**860HR**  
**90%/10%**  
**B3123 – 78" Width**  
**B3695 – 66" Width**

**760**  
**90%/10%**  
**B1838 – 78" Width**

**300 Rapide**  
**90%/10%**  
**B1995 – 78" Width**

**860 Professional**  
**90%/10%**  
**B1820 – 66" Width**

**860 Professional**  
**90%/10%**  
**B3536 – 78" Width**  
**Additional Colors:**  
**Burgundy, Spruce, Wine,**  
**Tournament Blue**

**6880 South Emporia Street Centennial, Colorado 80112**  
**303-790-0885 – 303-790-0746 – FAX**  
**Toll-Free: 1-800-525-7059**

**e-mail: [game@amusemp.com](mailto:game@amusemp.com) – [www.amusementemporium.com](http://www.amusementemporium.com)**

**AMUSEMENT EMPORIUM<sup>TM</sup> Inc.**  
**Staplers/Staple Pullers**

**Billiards**



**Duo-Fast**



**T1604 Staple Puller**



**T0554 Staple Puller**

**T0330 – Duo-Fast Electric Staple Gun**

- Dual Vents In Housing For Added Strength And Longer Life
  - Heavy Duty Return Spring Ensures Efficient Operation
- Durable Nickel-Plated Magazine Helps Prevent The Build Up Of Debris For Smoother Staple Feeding.

**This Staple Gun Is Designed For Quick And Efficient One-Handed Use. Feeds Staples As Fast As You Can Pull The Trigger. Lightweight For Effortless Tacking Over Extended Periods Of Time**

<p><b>Specifications</b>  <b>Weight: 4 lbs. 4 oz.</b>  <b>Dimensions: 6-3/4" H x 9" L</b>  <b>Fastener Range: 3/8" to 9/16"</b>  <b>Wire Gauge: 20</b>  <b>Wire Size: .05"</b>  <b>Crown Width: 1/2"</b>  <b>Load Capacity: 84</b>  <b>Mode of Operation: Electric – 115 VAC</b></p>
--

<b>Staples For T0330</b>		
<b>Size (Depth)</b>	<b>Stock#</b>	<b>Ref#</b>
1/4"	T0331	5008
5/16"	T0332	5010
3/8"	T0333	5012
1/2"	T0334	5016
(Staple Width Is 0.050")		

**Ideal For Use In The Amusement And Vending Industries**

**6880 South Emporia Street Centennial, Colorado 80112**  
**303-790-0885 – 303-790-0746 – FAX**  
**Toll-Free: 1-800-525-7059**

**e-mail: [game@amusemp.com](mailto:game@amusemp.com) – [www.amusementemporium.com](http://www.amusementemporium.com)**

**ESD Coin Chutes**

**Adjustable, Vertical**

**4-Up**

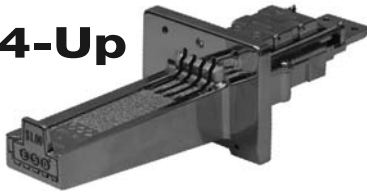

- I0035 – \$0.50 (2 X \$0.25)**
- I0053 – \$0.75 (3 X \$0.25)**
- I6027 – \$1.00 (4 X \$0.25)**
- I6034 – .900 (1 X .900)**



**I0036 – Spring**

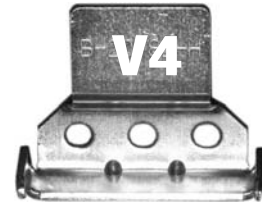

- I0055 – Spring Bracket Screw**
- I0056 – Spring Bracket – V4**
- I0089 – Spring Bracket – V5**

**5-Up**



- I0010 – \$0.50 (2 X \$0.25)**
- I0011 – \$0.75 (3 X \$0.25)**
- I0003 – \$1.00 (4 X \$0.25)**
- I0009 – \$1.00 (\$1.00 Coin)**
- I0007 – \$0.25 & 0.984 Token**



- I6024 – Shim, 0.015"**
- I6025 – Shim, 0.020"**

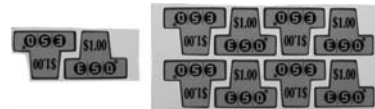

**Price Labels**

- I0034 – \$0.50**
  - I0031 – \$0.75**
  - I0032 – \$1.00**
  - I6030 – \$1.25**
  - I6031 – \$2.00**
- Packs of 10**

**8-Up**

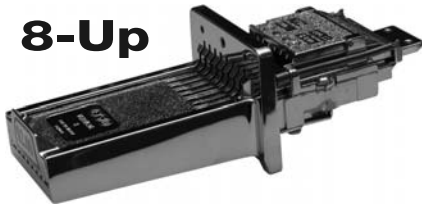

- I0014 – \$2.00 (8 X \$0.25)**

**Handles**

- I0016 – 4-slot**
- I0099 – 5 Slot**



**Includes  
Ratchet/Spring,  
Screw And Retainer**



**Inserts**

- I0033 – Black Plug**
- I0040 – \$0.25 New Style**
- I0057 – \$0.10**



**Bridges**

- I0058 – \$0.85**
- I4414 – V4, \$1.00**
- I4413 – V5, \$1.25**
- I4415 – V8, \$2.00**

**6880 South Emporia Street Centennial, Colorado 80112**  
**303-790-0885 – 303-790-0746 – FAX**  
**Toll-Free: 1-800-525-7059**

**e-mail: game@amusemp.com – www.amusementemporium.com**